

Attach blanking cover to fascia panel  
[NB. Only for BMW vehicles without  
switch panel under climate control  
unit]

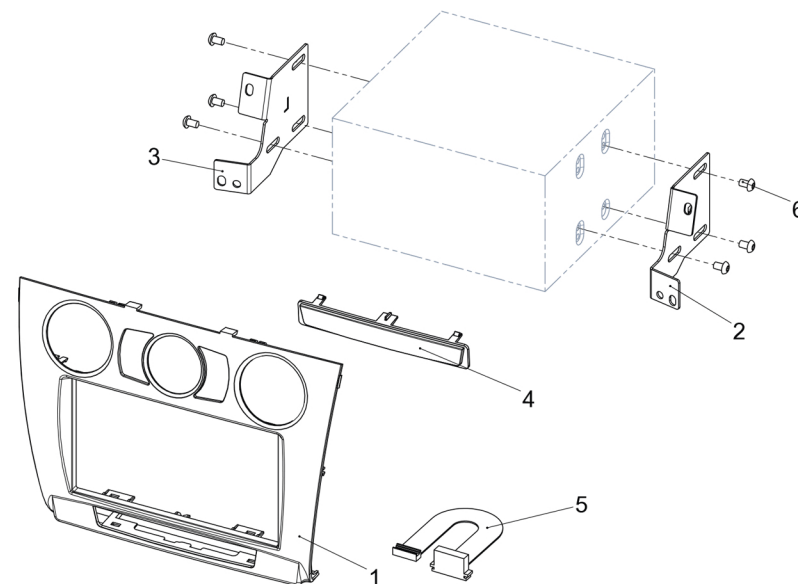

## BMW 1 Series (E87 Facelift) 2007>



*For vehicles with manual air conditioning, without iDrive*

1. Fascia Panel
2. Mounting Bracket [Right]
3. Mounting Bracket [Left]
4. Blanking Cover\*
5. Ribbon Cable

\*only required for models without switch  
panel under climate control



1. BMW 1 Series (E87) 2007 with switch bar under the climate control unit

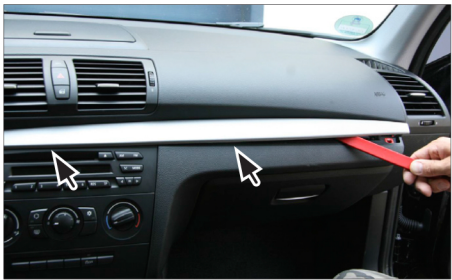

2. Use a panel removal tool to unclip the trim panel and remove



3. Using a panel removal tool, unclip the climate control panel and remove

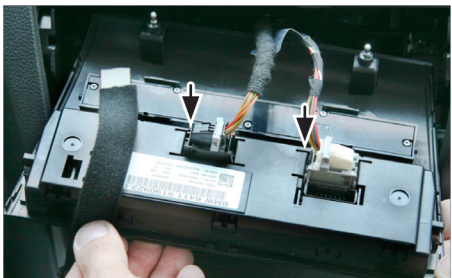

4. Carefully pull out the air conditioning unit and unplug the connections marked by the arrows in the image

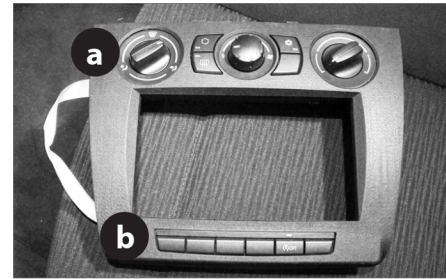

15. Attach the air conditioning unit (a) and switch bar (b) to the replacement fascia panel

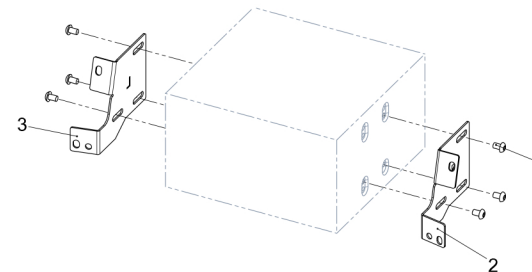

16. Attach mounting brackets to double DIN head unit and make all necessary connections.

Fix the head unit and bracket assembly into the dashboard



17. Push the fascia panel over the head unit until it clips into place.

Reinstall everything in reverse order of disassembly to complete your installation

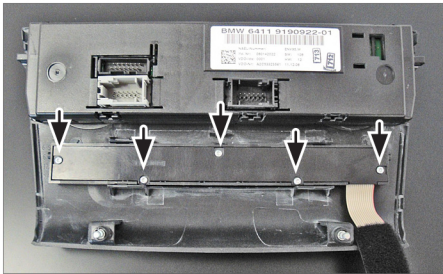

11. Remove [5] screws from the switch panel (See arrows) and remove the PCB board

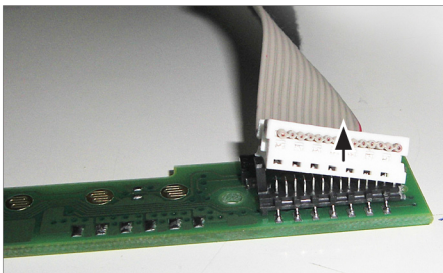

12. Disconnect the ribbon cable from the PCB board

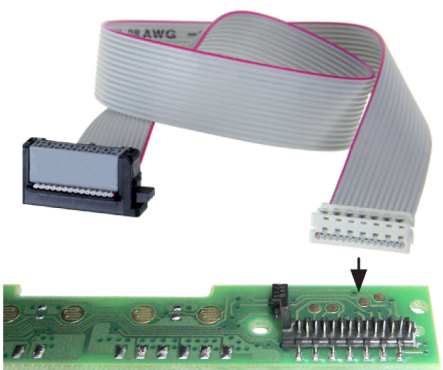

13. Attach the white connector of the replacement ribbon cable to the PCB board and reinstall the PCB into the switch panel

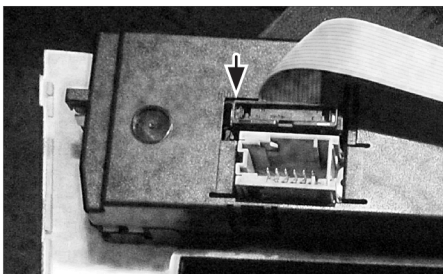

14. Attach the black connector of the ribbon cable to the air conditioning control unit

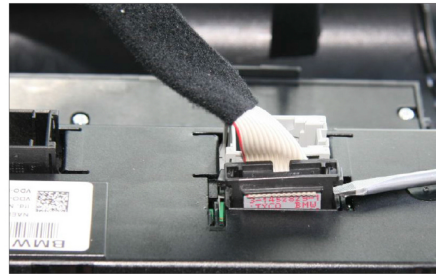

5. Remove the connector attached to the ribbon cable

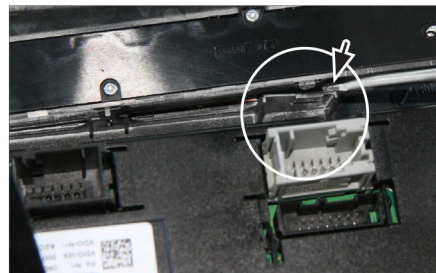

6. Unclip and remove the switch panel below the air conditioning control unit



7. Use a screwdriver to unclip and remove the air conditioning control unit

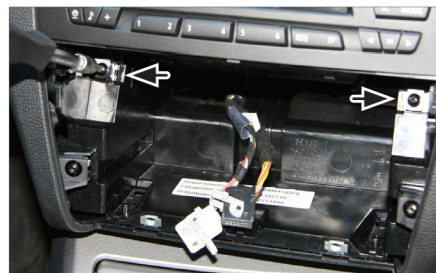
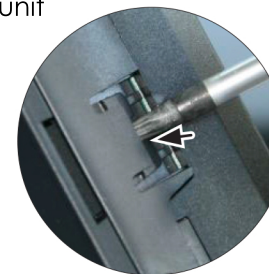

8. Remove the screws below the OEM head unit (See arrows)

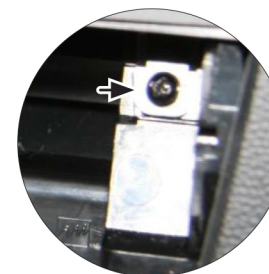



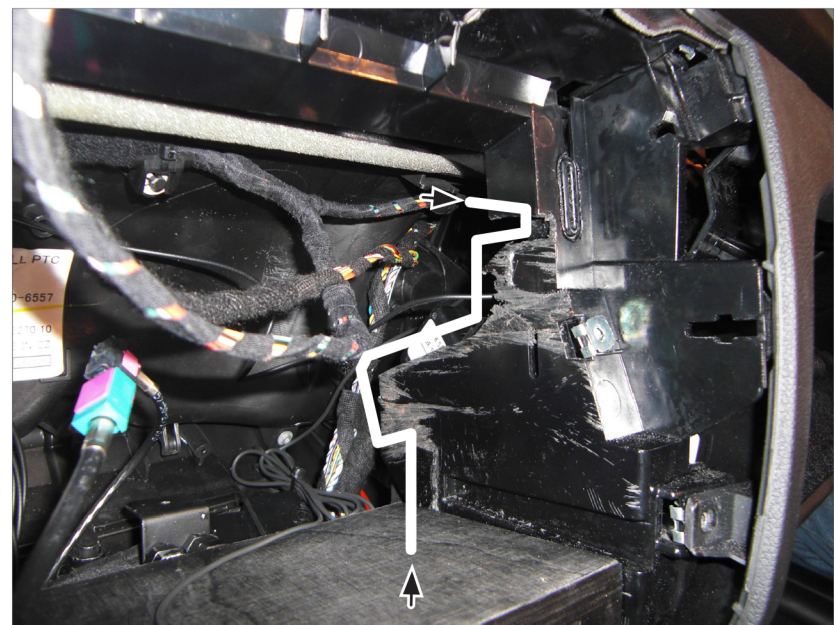
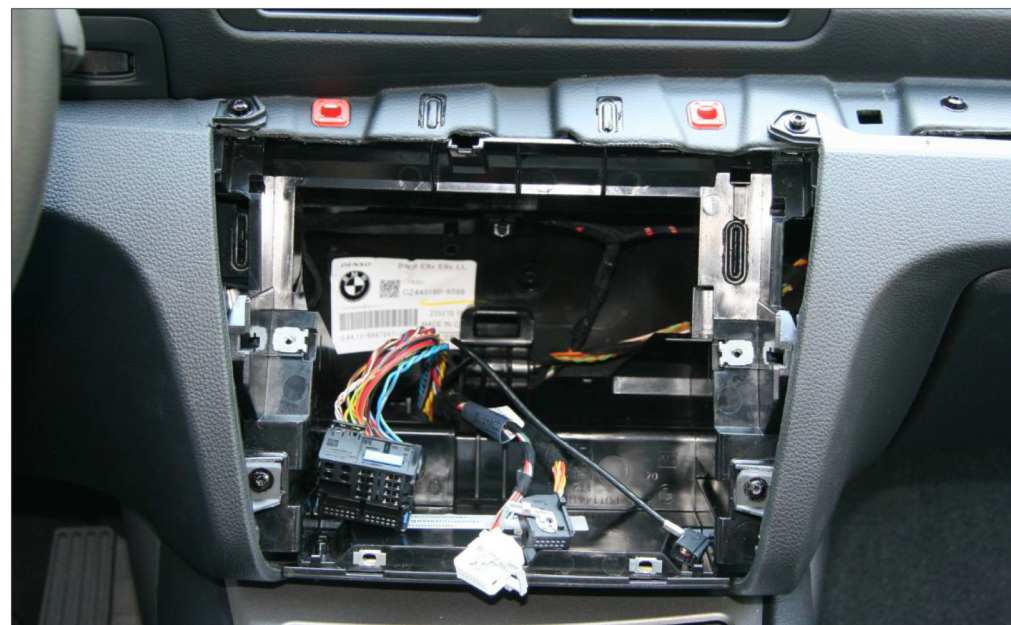
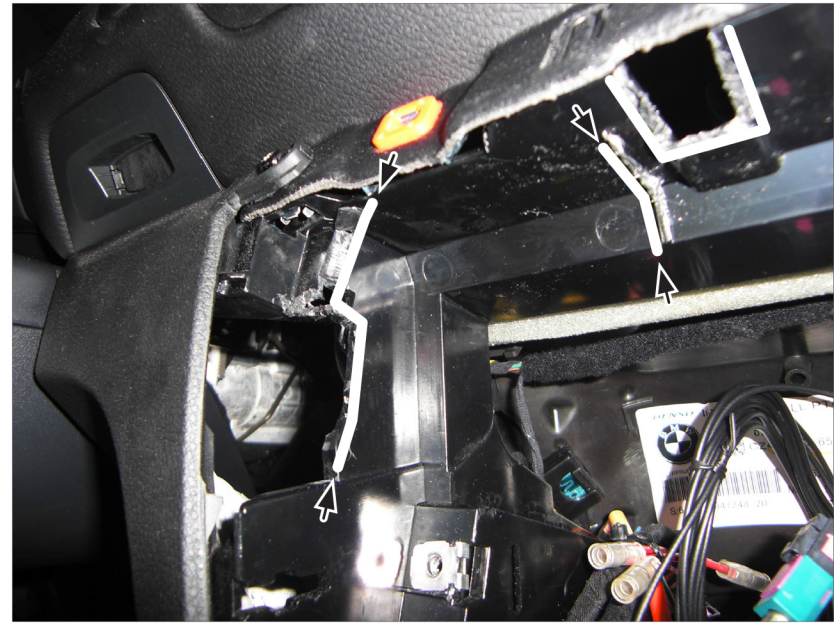

9. Remove OEM head unit

10. Cut away plastic area (as shown in images) to clear space for the head unit