



CT23MB25/L
Mercedes C Class W204
2011 - 2014



INSTRUCTION MANUAL

www.connects2.com

Designed and
Engineered
in the UK. 

Kit Contents

Item Number	Description	Qty
1	Button Relocation Panel	1
2	Button Relocation Panel Bracket Left	1
3	Button Relocation Panel Bracket Right	1
4	Button Relocation Panel Button Support	1
5	Rubber Mat	1
6	4.3mm x 8mm Self Tapping Screw	2
7	3.5mm x 8mm Self Tapping Pan/Pozi Screw	4
8	Facia Panel Bracket Left	1
9	Facia Panel Bracket Right	1
10	Facia Panel	1
11	M5 x 8mm Pan/Pozi Machine Screw	4
12	Extension Lead	4

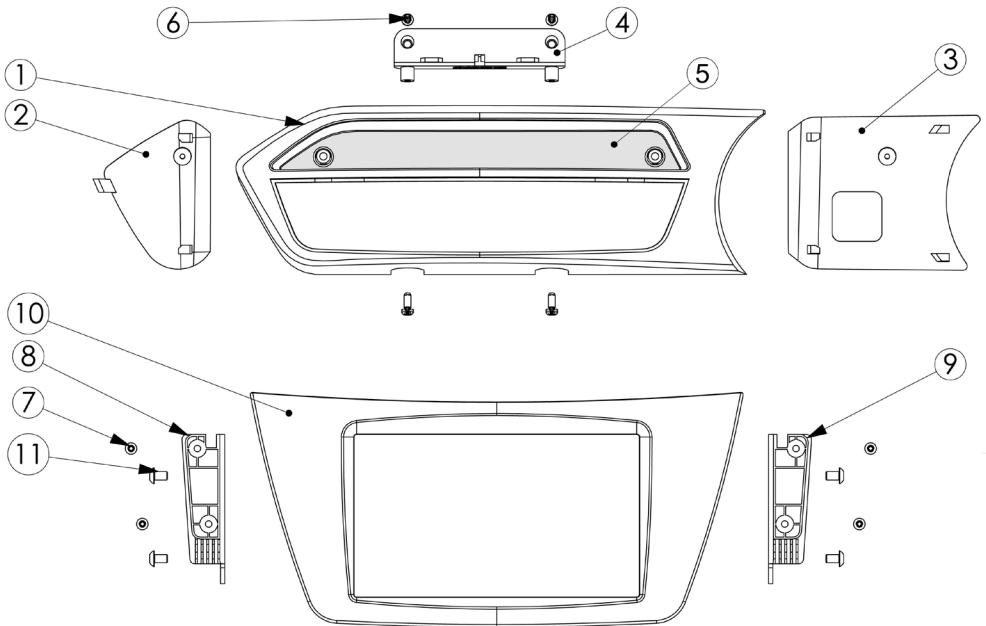

FITTING GUIDE

1. Using a plastic removal tool remove the air vent panel. Make sure you lever the clip out inside the air vents as shown in the right side image below.



2. When removing the air vent panel make sure you unplug the blue connector to the air vent controls.



3. Unscrew x2 screws on top of the head unit making sure you only unscrew the screws half way then push the screws down. This will unlock the head unit's bracket assembly.



4. Remove the head unit and unplug all connectors attached, including the connector attached to the fascia panel of the head unit.

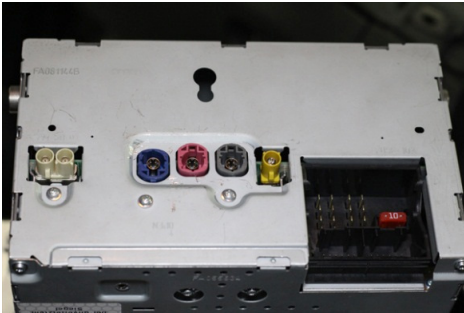

5. Image of the dash with the OEM system removed.



6. To remove the display panels (each side) push the panels inwards towards the display screen.



7. Fascia assembly: Screw the radio fascia brackets onto both sides of the fascia panel supplied in the kit. (2x screws each side - ITEM 7)

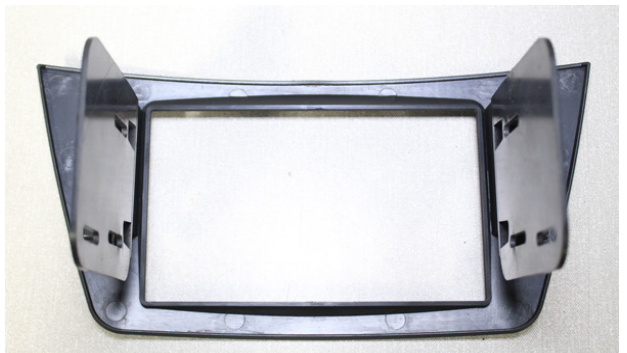
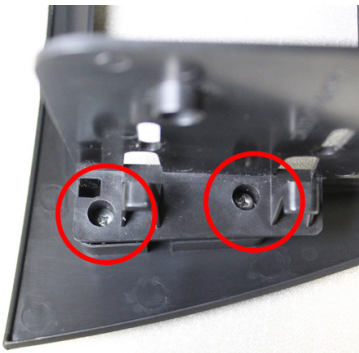

8. Sliding the fascia and brackets onto the head unit, screw the brackets onto the side of the head unit, making sure you align the head unit in position.

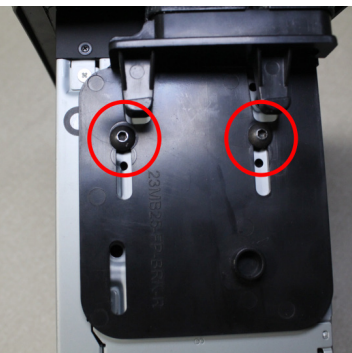

9. Unclip and remove the bottom display panel, this will give you more access to feed the extension cable through the dash.



10. Connect the extension cable to the white OEM connector that was unplugged from the head unit's fascia panel. Feed the cable up through the dash so the white connector comes out to the right side of the display screen.

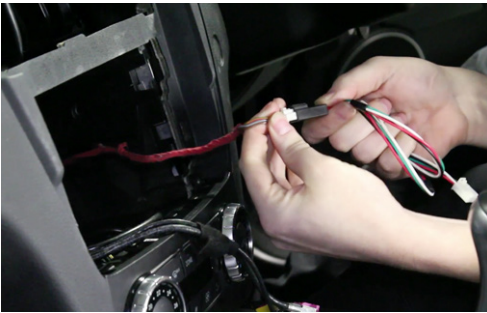

11. Connect to the two brackets on both sides of the display screen by pushing the brackets outwards from the display.



12. On the OEM head unit unscrew the four screws on the bottom of the button panel and remove the button panel.



13. Clip the button panel into the display panel supplied in the kit.



14. Using the plastic bracket supplied in the kit, connect to the back of the button panel assembly and secure with 4 screws highlighted in the picture. (ITEM 6) **Please Note - Do not use the OEM screws as they will pierce the fascia**



15. Place the button panel assembly in front of the display screen. Screw the panel into place – Screws highlighted in the picture, then push the rubber mat into position.

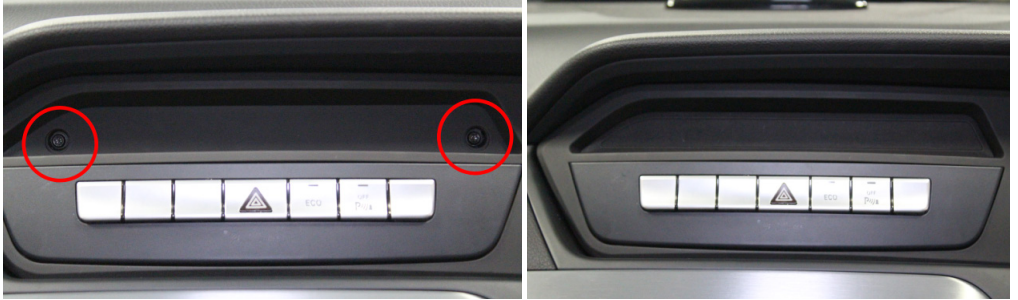

16. Re-install head unit, wiring and all panels then test the system.

