

This camera retention interface allows you to retain the original OEM factory fitted camera on a Honda 2vn3 navigation system when installing a new aftermarket head unit.

This interface is suitable for 2VN3 units with 7 and 8 PIN grey connectors

PLEASE NOTE: For 2VN3 Navigation Systems only. Please check connections on the OEM radio for compatibility

INSTALLATION DIAGRAM

PLEASE NOTE: The diagram below shows an overview for the installation of this product. Please turn over the page for step by step instructions.

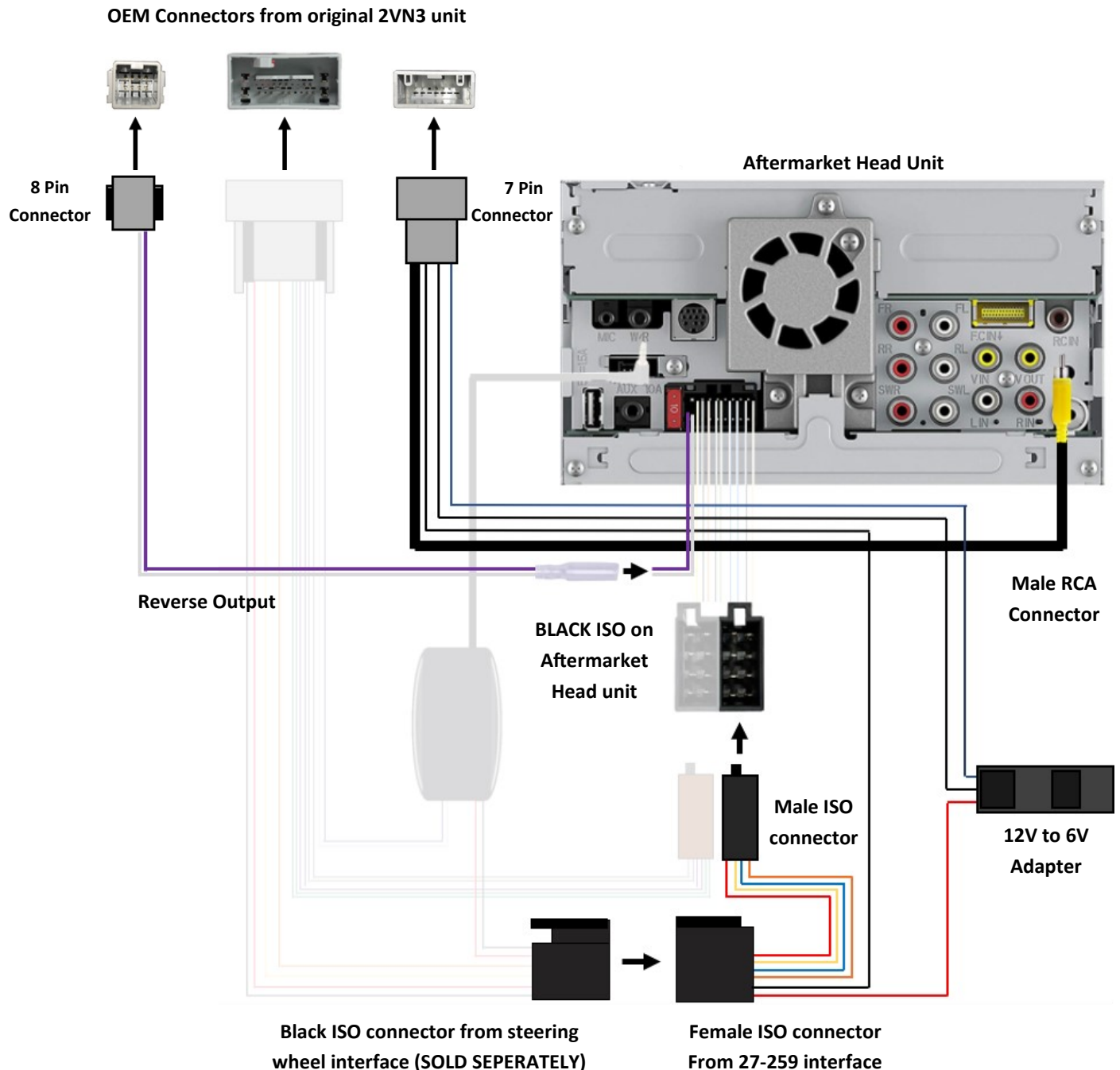

INSTALLING WITH AFTERMARKET SWC INTERFACE

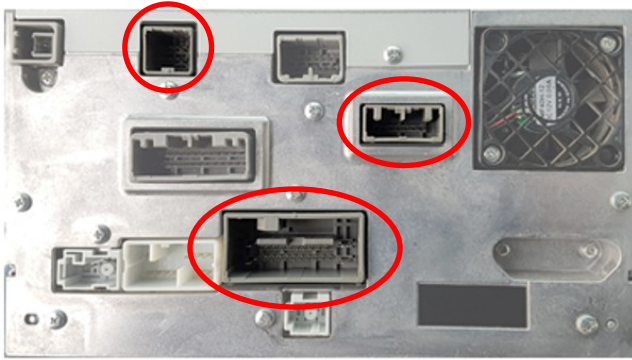

1. Disconnect the original OEM radio from the car. Make a note of the connections highlighted (Left Image)
2. Set up your aftermarket head unit as per the manufacturers instructions
3. Plug in the car specific Steering wheel interface as per the manufacturers instructions.

NOTE: Make sure you leave the Black ISO connector from the steering wheel control interface unplugged, this is used in the next step of the installation.

The installation should be starting to look a little something like this

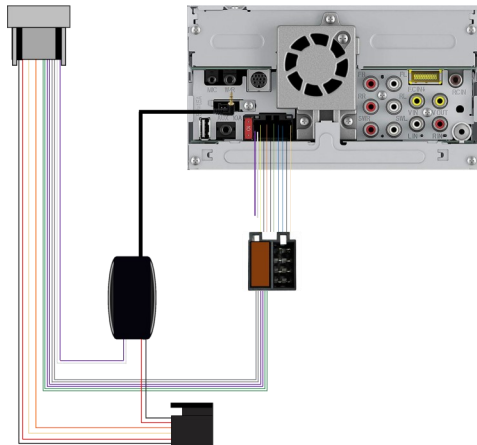

STEP 4

Connect the black ISO from the steering wheel interface (A) to the female ISO connector on the camera interface (B) **Then** Connect the Male ISO connector of the camera interface (C) to the wiring loom of the aftermarket head unit (D)

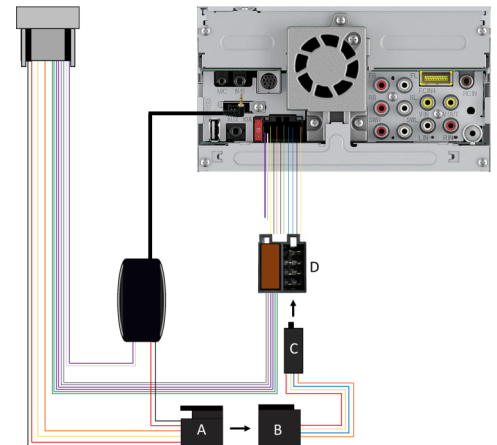

STEP 5

Connect the male RCA Plug of the camera interface to the camera input of the aftermarket head unit. This is usually a Brown Female RCA connection on the back of the unit but can vary depending on the manufacturer.

NOTE: Refer to the manufacturers instructions to confirm camera input connection.

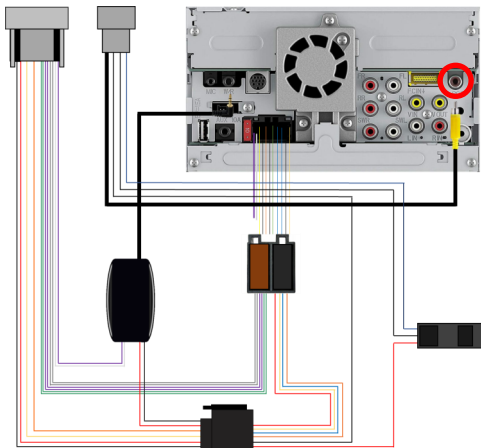

STEP 6

Connect the bullet end of the wire labelled "Reverse Output" to the loose reverse wire (Usually a Purple/White wire) leading out from the aftermarket radio wiring harness.

NOTE: These colours can vary depending on the make of head unit. Please refer to the manufacturers instructions.

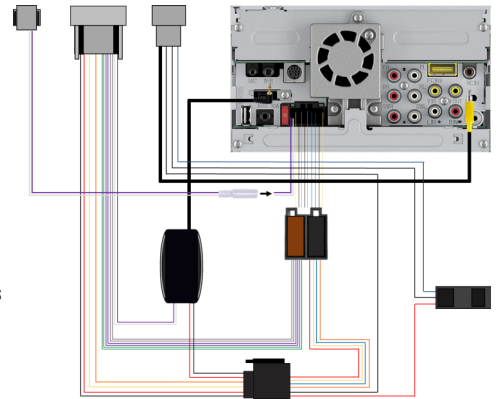

STEP 7

Connect the 3 Grey connectors (top left) to the original connections coming from where the original radio was.

NOTE: The Grey connector should look similar to the ones shown on the back of the OEM radio in step 1

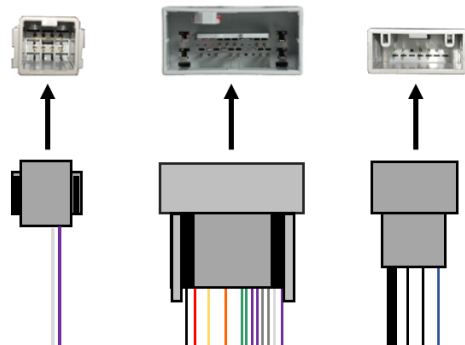

STEP 8

Go into the menu settings on the aftermarket head unit to activate/turn on camera.

NOTE: Picture is for demonstration purposes only and varies depending on the head unit you are installing. Refer to the manufacturers Instructions on how to do this.

